

Primary lithium battery system BA 5380

6 V Primary lithium manganese dioxide (Li-MnO₂) battery

The battery consists of 2 LM 33550 cells connected in series.

Key Features

- A non-replaceable fuse is incorporated on the battery negative
- A normally closed thermal fuse (TCO) is incorporated in the battery. It is non-replaceable and non-resettable
- A blocking diode is incorporated to prevent charging
- A non-replaceable fuse is connected between the two cells for added safety
- A complete discharge device (CDD) with LED activation indicator is built into the battery. The CDD consists of a manually activated switch to connect a resistor for discharging the battery to 0 V
- Made in the U.S.A.

Typical applications

- AN/PSN-11 GPS
- AN/PSN-10 (V) GPS
- Chemical Agent Monitor



Electrical characteristics

Typical OCV	6.0 V
Nominal voltage (at 500 mA)	5.4 V
Cut-off	4.0 V
Typical capacity +21°C / +70°F (at 250 mA discharge current)	13 Ah
Operating temperature	-40°C to +71°C / -40°F to +160°F
Storage (Recommended max) (Possilbe)	+35°C / +95°F -40°C to +71°C / -40°F to +160°F

Physical characteristics

Max weight	327 g / 11.5 oz
Weight of Li metal content	7.4 g / 0.26 oz
Max OD	35.51 mm / 1.398 in
Max height	128.5 mm / 5.059 in
Battery case	Plastic

References

Reference specifications	MIL PRF 32271 or Saft standard specification
Nato Stock Number	6135-01-517-4954

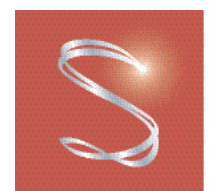

SAFT

BA 5380

BA 5380 dimensions
 *All measurements in inches

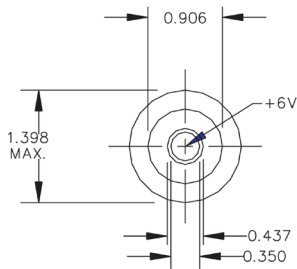
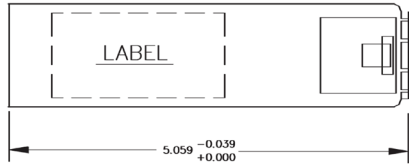

Electrical schematic

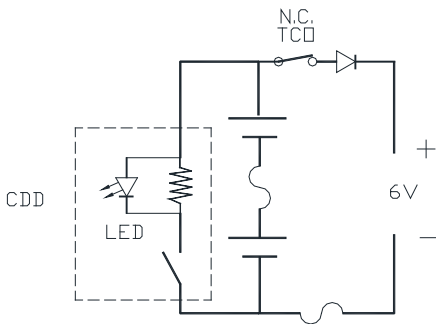

Voltage plateau versus current and temperature

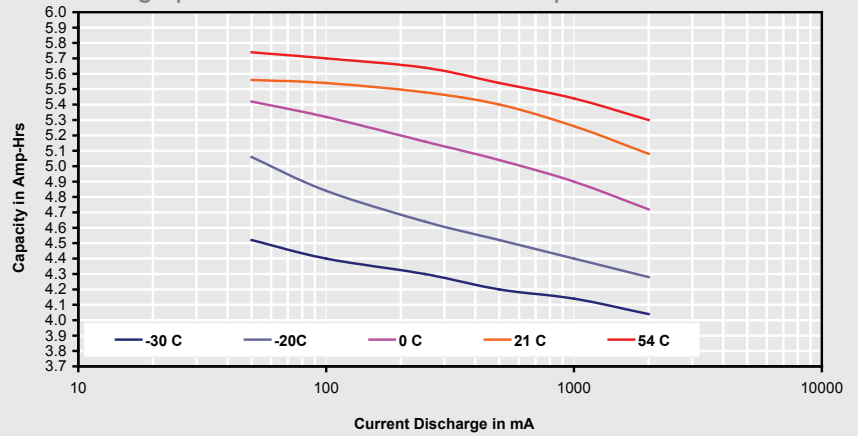

Capacity versus discharge and temperature

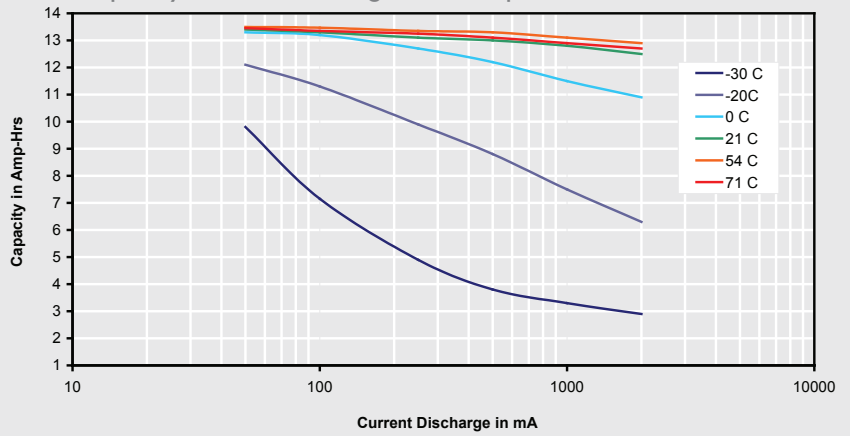

Typical discharge curves at +21 °C at various discharge currents

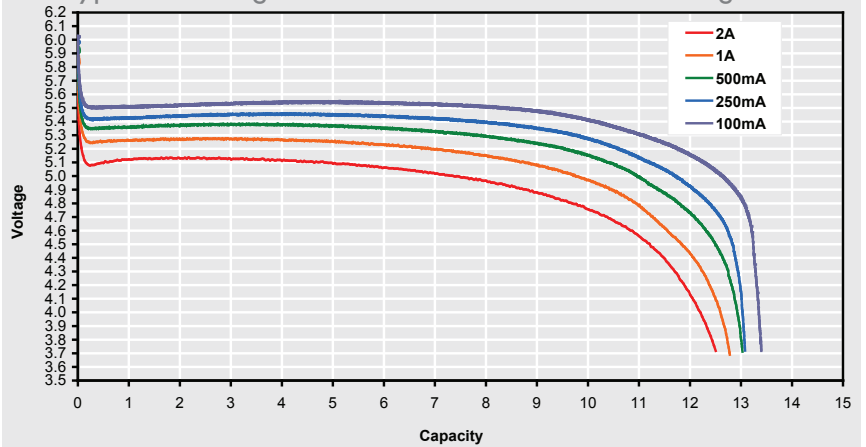

Saft
 Specialty Battery Group
 12, rue Sadi Carnot
 93170 Bagnolet France
 Tel.: +33 (0)1 49 93 19 18
 Fax: +33 (0)1 49 93 19 69
 www.saftbatteries.com

Saft
 Specialty Battery Group
 313 Crescent St.
 Valdese, NC 28690 - USA
 Tel.: +1 (828) 874 4111
 Fax: +1 (828) 874 3981
 www.saftbatteries.com

Doc N° 32036-2-0912
 Edition: September 2012
 Information in this document is subject to change
 without notice and becomes contractual only after
 written confirmation by Saft.
 Published by the Communications Department
 Photo credit: Saft